

Glasses-type Wearable Device

InfoLinker™

Quick Guide

Model No. WUZ-01B

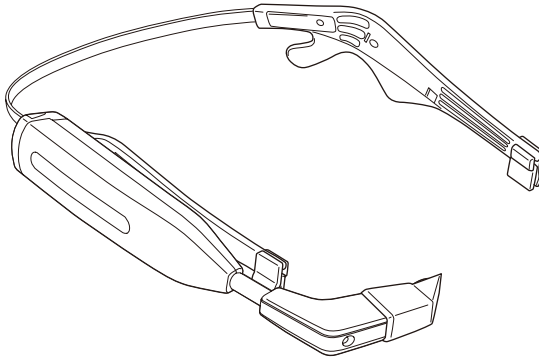

CE



Read the “Safety precautions” section before start using this device and use the device correctly. In addition, keep this manual at a place where a user can use whenever necessary.

For detailed operations, refer to the User manual.

The User manual is available for downloading on the following web site.

<http://www.westunitis.co.jp/en/>



Table of Contents

Introduction	3
Intended use	3
Users	3
Service life	3
Safety precautions	4
Product documentation	10
Checking the accessories	10
Before Use	11
Names and functions of components	11
Charging the batteries	12
Inserting and replacing batteries	13
How to Wear the Device	14
Basic Operations.....	15
Examples of major operations	15
Turning On/Off the Power.....	16
Turning on the power	16
Turning off the power	16
Sleep mode	16
Turning on/off the display (screen).....	17
Home Screen	18
Displayed information.....	18
Development Environment	20
Specifications.....	21
Trademarks	22



Introduction

Thank you very much for choosing our product, InfoLinker “WUZ-01B.”

Intended use

This product is used by attaching to the temporal part in combination with the glasses and provided neckband with intension of easing the indoor navigating and picking works and remote operations in a factory and a warehouse. Before start using this product, analyze the risks that may exist while using this product and check the safety thoroughly.

Users

Users need to understand the contents of this manual for safe and correct use of this product.

We recommend that any person who corresponds to one of the following conditions refrain from using this product.

- Person who is wearing medical electric equipment such as an implanting type pacemaker or an implanting type defibrillator
- Person who has health history of photosensitivity
- Person who has a heart disease
- Person in poor physical condition
- Person with poor sleep
- Person who is tired
- Person who has influence of alcohol



Service life

3 years. This service life is expected only if you use the product properly according to this manual and the user manual.



Safety precautions

This section describes precautions to use the product in safety and to avoid putting yourself, other people, and your property at risk.

The words DANGER, WARNING, and CAUTION convey special meanings. Follow the instructions precisely while you use the product.

 DANGER	A Danger indicates a hazard with a high level of risk which, if not avoided, will result in death or serious injury.
 WARNING	A Warning indicates a hazard with a medium level of risk which, if not avoided, could result in death or serious injury.
 CAUTION	A Caution indicates a hazard with a low level of risk which, if not avoided, could result in minor or moderate injury, damage to the property.

Examples of pictorial images

	Alert symbol
	Symbol for "Prohibitions (Must not do)."
	Symbol for "Compulsory actions (Must do)."

Handling of InfoLinker, battery charger, battery, and AC adapter

DANGER



Always wear the device with the glasses.

Otherwise, an injury may cause such as by hurting the eye by the display.



Before start using the device, confirm the safety in the surrounding environment.

While watching the images, recognizing the surrounding conditions becomes difficult. If there is any fragile object or obstacle, an injury or an accident may occur.



Do not use the device while driving a car, motor cycle, or a bicycle.

Otherwise, a traffic accident, tumbling, or falling accident may occur.



When stopping by a place which handles the flammable gas such as a gas station, be sure to remove the battery from the device in advance. Do not charge the battery either.

Otherwise, the gas may catch a fire.



Use of specified battery, battery charger, and AC adapter.

Using a battery, battery charger, or AC adapter other than those specified may result in varied charging results, fire, damage, explosion, or leaking.

WARNING



Do not use the device continuously for a long time.

Use the device by taking sufficient breaks periodically.



Do not use the device while moving.

Otherwise, tumbling or traffic accident may occur.



Do not use the device with a high volume for a long time.

Otherwise, hearing disorder may occur. Set to a proper volume.



CAUTION



Do not use, store, or charge the device in the following places.

- Hot place such as near fire or heating equipment
- Place exposed to the direct sunlight (such as inside of a vehicle on a sunny day)
- Place with abrupt temperature changes
- Place with high humidity such as near water or place where water may splash
- Dusty place

Otherwise, fire or malfunction may occur.



Do not use or store the device at a place where is near the corrosive chemical, corrosive gas, or emission of oily smoke.

Otherwise, malfunction or loss of internal data may occur.



Remove the battery when storing the device.

Otherwise, the device may get broken by leakage from the battery.



Do not dismantle, repair, or modify the device.

Otherwise, fire, burn, injury, electrical shock, or malfunction may occur.

If a repair is necessary, consult the sales office.



Do not splash water or immerse in the water.

Otherwise, fire, burn, or electrical shock may occur.



If liquid such as water enters inside of the device, stop using the device and remove the battery.

Otherwise, fire, malfunction, or burn may occur.



Do not give strong force or shock, throw, or put a heavy object on the device.

Otherwise, leakage, rupture, or ignition of the battery, malfunction of the device, or fire may occur.



If the device emits smoke, strange odor or sound, or excessive heat during a use or charging, take the following measures.

During use : Remove the battery from the device.

While charging : Pull out the AC adapter cord from the plug and remove the battery from the charger.

Otherwise, the battery may rupture, and fire or burn may occur. Consult the sales office.



Do not use the device that is broken.

Otherwise, fire, burn, or electrical shock may occur. Consult the sales office.



Remove the battery from the device at a place where using the device is prohibited, such as in a hospital or on an air plane.

The device may adversely affect electric devices or medical electric devices.

Be sure to follow the instructions from the staff of the medical institution or the airline company.

A passenger who takes prohibited actions on an air plane may get punished according to the law.



When a radio disturbance occurs in other equipment during use of this device, stop using the device.



Do not use the device if a user is wearing medical electric equipment such as an implanting type pacemaker or an implanting type defibrillator. In addition, do not use the device near such medical electric equipment.

Otherwise, the medical equipment may get adversely affected by the radio wave of the device.



If any strange feeling occurs on the skin, immediately stop using the device.

Otherwise, itch, irritation, or eczema may occur according to the constitution and the health condition of the user. Consult a dermatologist.



If any abnormal condition such as tiredness or discomfort occurs during a use, stop using the device.

Handling of the device



CAUTION



Do not let a conductive foreign object (metal piece, pencil lead, etc.) contact the 4-pole mini jack, battery insertion opening, and micro USB connection terminal. In addition, do not let such foreign object enter inside the device.

Otherwise, fire, burn, injury, or electrical shock may occur.



Do not leave the external connection terminal cover, battery insertion opening cover, and other covers opened.

Otherwise, dust or water may enter, causing malfunctions.



Do not pull or twist with excessive force.

Otherwise, malfunctions may be caused.



In case the display breaks by dropping or inside of the equipment becomes exposed, do not touch the broken display or exposed component.

Otherwise, an injury or electrical shock may occur by the broken sections.

How to handle the battery charger



WARNING



Unplug the power cord when the charger is not in use.

Otherwise, fire, heat generation, electrical shock, or malfunction may occur.



CAUTION



Do not let a conductive foreign object (metal piece, pencil lead, etc.) contact the battery charging terminals.

Otherwise, fire, burn, injury, or electrical shock may occur.



In case inside of the device becomes exposed by dropping and damaging the device, do not touch the exposed component.

Otherwise, an injury or electrical shock may occur by the broken sections.

Handling of batteries



DANGER



If the liquid inside of the battery gets into an eye, immediately wash the eye with water and see a doctor.

Otherwise, the eye may lose a vision.



WARNING



Do not use a battery that is deformed by dropping, leaking, has strange odor, or swelling.

Otherwise, leakage, heat generation, bursting, or ignition may occur.



Do not give a strong shock or stamp on the battery.

Otherwise, leakage, heat generation, bursting, or ignition may occur.



CAUTION



Do not carry or store the battery with metal items.

Otherwise, leakage, heat generation, bursting, or ignition may occur.



If the liquid inside of the battery attach on the skin or cloth, immediately rinse with water.

Otherwise, the skin may be injured.



Do not charge a wet battery.

Otherwise, heat generation, ignition, or bursting may occur.



If charging the battery does not complete within the specified charging time, stop charging.

Otherwise, leakage, heat generation, bursting, or ignition may occur.

Handling of the AC adapter



WARNING



Do not touch the AC adapter cord while it is thundering.

Otherwise, electrical shock may occur.



CAUTION



Do not damage the cord.

Otherwise, fire or electrical shock may occur.

- Do not process the cord.
- Do not place a heavy object on the cord.
- Do not forcibly bend, twist, or pull the cord.
- Do not place the cord near the heating equipment.

When the power cord is broken, contact the sales office.



Use the AC adapter with the specified power source and the power voltage.

Otherwise, fire or malfunction may occur.

AC adapter: 100 - 240 VAC, 50/60 Hz

Product documentation

- **Quick guide (this manual)**

It explains the basic functions and operations of this device.

- **User manual**

It explains operations of various functions, applications, and settings.

- **Compliance information**

It describes legal requests and compliance information to the related regulations.

The User manual and compliance information are available
for downloading from the following web site.

<http://www.westunitis.co.jp/en/>

Information

- Reprinting a part of or entire section of this manual without permission is prohibited.
- Screens and illustrations used in this manual are only the images. Therefore, they may be different from actual screens or products.
- The contents of this manual are subject to be revised without a prior notice.

Checking the accessories

- Quick Guide

- InfoLinker storage case

- Neckband
WUZ-NB01



- Battery (x5)
WHB-001

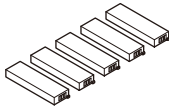

- Battery charger
WUZ-AC01

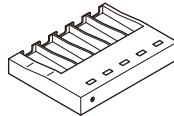

- AC adapter for battery charger

One of the following is included.
GF12-US0520
GF12E-US0520



Before Use

Names and functions of components

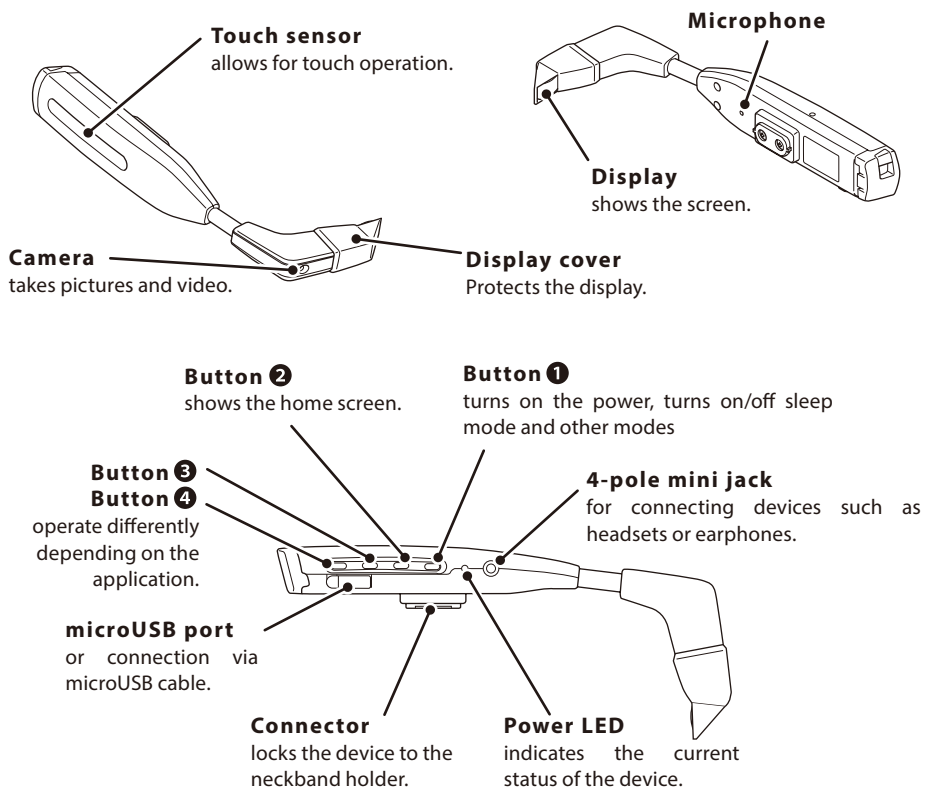

- NOTE**
- Button and sensor functionality vary depending on the application.
 - Press and hold a button means to release after pressing and holding the button for approximately 1 second.

Voice functions

This device is not equipped with a speaker. In order to play back the voice, connect the ear phone or a head set to the 4-pole mini jack. In addition, to have talk through the device, connect the head set.

NOTE

When connecting an ear phone or a head set to the 4-pole mini jack, make sure that the connected unit is fully inserted. If not, noise may be caused.

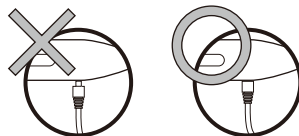

Charging the batteries

Fully charge the battery prior to first use, and recharge the battery when it is drained.

Charging the battery for the first time will take approximately 2 hours.

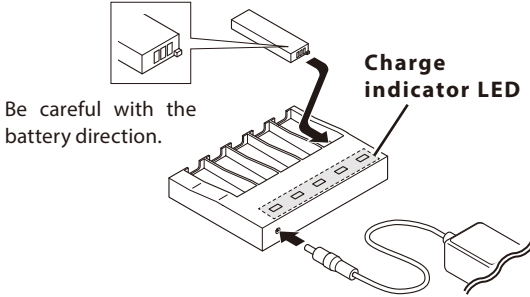

Battery charge indicator

Charging state	Charge indicator LED state
No battery inserted	Not lit
Charging	Green light
Charging complete	Blinking green light
Abnormal temperature	Blinking red light
Abnormal charge	Red light

Insert the plug into an outlet.

- NOTE**
- The LED may blink in red when a battery is inserted into the charger. If this happens, remove the battery, wait for several seconds and insert again.
 - If a fully charged battery is inserted into the charger, the LED may not turn on.

Battery Maintenance

If the battery terminal becomes dirty, clean with a soft, dry cloth. Getting finger oil, sweat, or dust on the terminal may prevent proper charging.

NOTE

Do not use organic solvents (benzene, thinner, and like), acids, or alkalis.

Inserting and replacing batteries

Inserting method

1. Move up the switch and open the cover.

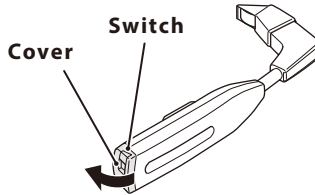

2. Raise the battery holder and insert the battery.

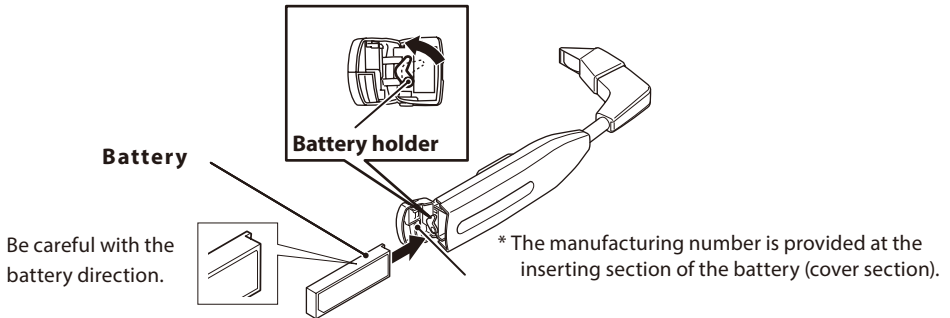

Replacement method (hot swap)

The battery can be replaced without turning off the power.

1. Hold the button ❶ (the foremost button) for longer than 1 second.

The power LED starts blinking. After a few seconds, it switches to the slow blinking state with intervals of approximately 2 seconds.

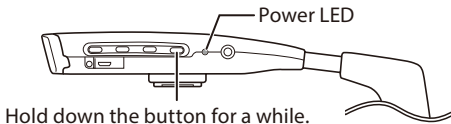

2. Remove the used battery. Then within 15 seconds, insert the charged battery. When the hot swapping succeeds, the power LED starts blinking in 2-second intervals again. If the hot swapping fails, the power LED turns off.
3. Press the button ❶ (the foremost button).
Resume the paused application from where it is stopped.

How to Wear the Device



Warning



Always wear the device with the glasses.

Otherwise, an injury may cause such as by hurting the eye by the display.

Use a provided neckband.

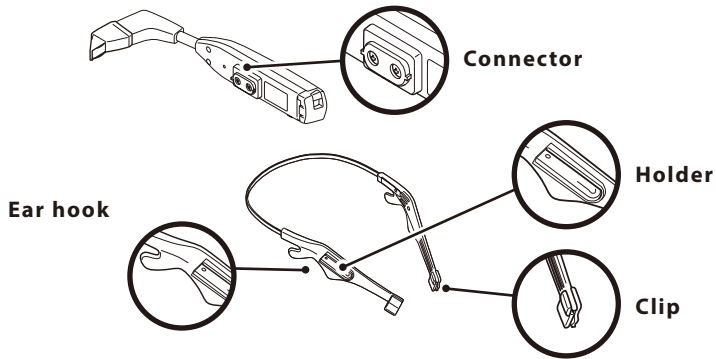

1. Slide the device connector to insert it into the neckband holder.

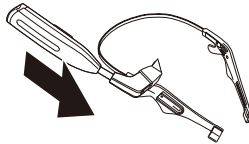

2. While wearing the glasses, attach the clip to the temple of the glasses.



Regarding clip size (Small, Medium, Large)



Clips can be replaced to fit the width of the temples. They can be used oriented either inward or outward.

NOTE • When taking off the device temporarily, detach the temples of the glasses from the clips and put the neckband around your neck.



When wearing on the left eye

The display can be rotated 180 degrees. Download and read the User manual (P10) for details.

Basic Operations

The user can operate this device intuitively by using the touch sensor.

When a user is wearing gloves, the touch sensor does not respond.

Examples of major operations

- Swipe from back to front

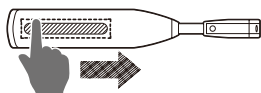

- Display the applications sequentially (clockwise order) on the Home screen.
- Display the next image
- Play back the next video.
- Zoom in to double the displayed image/video in Camera and Record

- Swipe from front to back



- Display the applications sequentially (counterclockwise order) on the Home screen.
- Display the previous image
- Play back the previous video.
- Zoom out the displayed image/video in Camera and Record

- Two-finger swipe from back to front

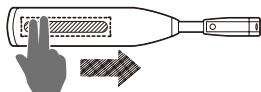

- Zoom in to decouple the displayed image/video in Camera and Record

- Two-finger swipe from front to back

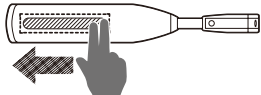

- Zoom out the displayed image/video in Camera and Record

- Single tap



- Auto-focus in Camera and Record

- Double tap



- Start-up of the application

- Tap and hold ... To release after pressing and holding for 1 second or more.



- Return the zoom factor to 0 in Camera and Record

Turning On/Off the Power

Turning on the power

Press the button ❶ (the foremost button).

The power LED turns on, and the startup screen opens on the display.

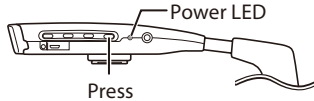

*Note that pressing and holding the button does not turn on the power.

Turning off the power

To turn off the power, remove the battery.

1. Hold the button ❶ (the foremost button) for longer than 1 second.

The power LED starts blinking. After a few seconds, it switches to the slow blinking state with intervals of approximately 2 seconds.

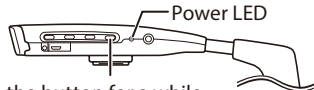

Hold down the button for a while

2. Then remove the battery.

Sleep mode

In the sleep mode, the display turns black, which disables erroneous operations from the touch operation. In addition, the battery power can be saved by using this mode while the operation is in pause.

Hold the button ❶ (the foremost button) for longer than 1 second.

The power LED starts blinking. After a few seconds, it switches to the slow blinking state with intervals of approximately 2 seconds.

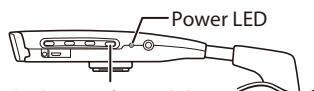

Hold down the button for a while

The power LED continues blinking while in the sleep mode.

Pressing the button ❶ (the foremost button) again releases the sleep mode.

Turning on/off the display (screen)

The display (screen) can be switched between on/off.

Even when the display is off, the application is continuously working. Therefore, consumption of the battery power continues. To save the power, shift to the sleep mode.

Press the button ❶ (the foremost button).

The display and the power LED turn off.

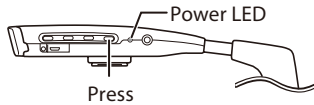

Pressing the button ❶ (the foremost button) again recovers the display.

Home Screen

On this screen, applications can be selected and started both by touching and by operating buttons.

Displayed information

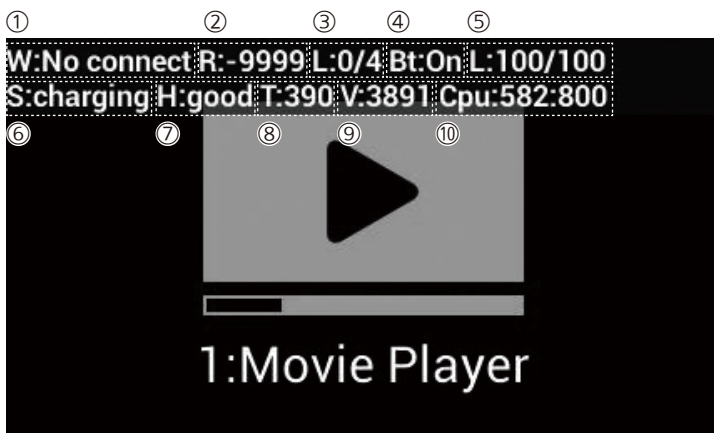

- ① W : SSID (Wi-Fi connection point)
When a Wi-Fi access point could not be found ... No connect
When Wi-Fi function is OFF ... off
- ② R : RSSI (Receive signal strength indicator)
- ③ L : Radio signal level MAX: 4
- ④ Bt : *Bluetooth* ON/OFF
- ⑤ L : Remaining battery
- ⑥ S : Battery status (discharging/charging/not charging/full)
- ⑦ H : Battery health (good/overheat/voltage/dead)
- ⑧ T : Battery temperature (The last digit indicates 0.1 degrees)
- ⑨ V : mV
- ⑩ Cpu : CPU temperature (The last digit indicates 0.1 degrees) : Clock frequency

Initial application

The following applications are installed as the standard specifications.

Download and read the User manual (P10) for details.

1. Movie Player: Plays back movie files.
 2. Image Viewer: Displays image files.
 3. Camera: Captures still images.
 4. CameraImages: Displays still images that are captured by using the Camera application.
 5. Record: Records movies.
 6. RecordMovies: Plays back movies that are recorded by using the Record application.
 7. FunctionCheck: Checks the basic operations of this device.
 8. Config by QR: Reads QR codes. It is used for the connection with the wireless LAN.
 9. Law: Displays the information and the product logo of this device that comply with the law.
 10. Setting : Checks and changes the network setting, device setting, personal setting, account setting, and system setting.
- RMS : Supports remote operations by bidirectional communications by "Image and Voice."
 - RMSScreenShot : Application that displays the screen shots that are captured by using the RMS application.
 - ROTATE : Rotates the display 180 degree.

Applications are displayed in the following order when the following operations are performed.

- **Touch operation:** Slide from the back to the front.
- **Button operation:** Pressing the last button.

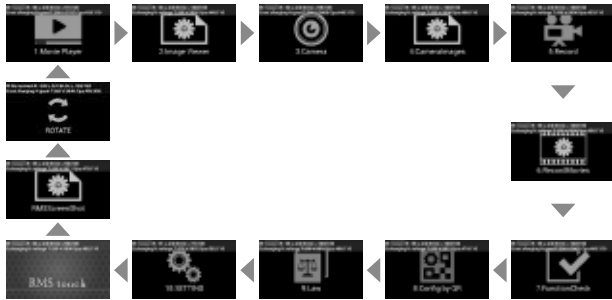

- Above information applies to the standard application in the default condition. The application contents of the actual device may have been changed.
- Refer to the User manual or contact the person in charge of setting of this device for any questions regarding settings or the applications.

Starting up the application

1. Display the application to be started using the procedure above.
2. Double tap on the touch panel, or hold the button ④ (the backmost) for longer than 1 second.

Development Environment

The entire set of the development environment for this device is provided on our web site. When setting the device or customizing the applications, confirm the user policy first. Then download the necessary sources from the following web site.

Note that we do not support or guarantee the safety of files or applications developed using this environment. Also note that the environment specifications may be changed or deleted without notice.

Use at your own risk.

Development Environment

<http://www.westunitis.co.jp/en/>

InfoLinker development environment kit contents

- InfoLinker Development.txt (Explanatory material regarding the development environment)
- Android Development Environment (provided by Google) (URL only)
- InfoLinker Drivers
- WUQR (InfoLinker QR Code creation application) (For Windows or Mac)*
- AdbInput (InfoLinker development support application for Windows*)
- InfoLinkerSamples (Sample sources)

* Download and read the User manual (P10) for details of the Android application "WUQR."

Specifications

Device	
Model No.	WUZ-01B
Approximate weight	50g
Resolution	WQVGA (428x240)
Aspect ratio	16 : 9
Field of view (approximate)	14 degrees
CPU	TI OMAP 4470 dual-core MAX1.5GHz
OS	Android 4.2.2
RAM (main memory)	1GB
ROM (user memory)	8GB
Sensor	3-axis accelerometer, 3-axis gyro, 3-axis magnetic
Camera resolution	1992 x 1216 effective pixels
Microphone	16bit Monaural microphone
Voice input / output	4-pole mini jack
<i>Bluetooth®</i>	Bluetooth 3.0 (A2DP / AVRCP / ANP / PASP / TIP / SPP / ICP / HFP / HID) Supported frequency band: 2402MHz-2480MHz Max. output: 6.3mW BLE mode is not supported.
Wireless LAN	IEEE 802.11 a/b/g/n Supported frequency band: 2412MHz-2452MHz, 5150MHz-5250MHz, 5250MHz-5350MHz Max. output: 7.9mW
USB port	Micro-B
Usage/Storage environment (Including accessories)	Temperature: 5 - 35°C, Humidity: 10 - 80% (no dew condensation)
Battery	
Model No.	WHB-001
Battery type	Li-ion polymer
Battery life	Approximately 1 hour * actual life will vary depending on the application
Battery voltage / power	DC 3.7V / 1.1Wh
Battery capacity	300mAh
AC adapter for battery charger	
Model No.	GF12-US0520, GF12E-US0520
Rated input	AC 100-240V, 50/60Hz
Rated output	DC5V, 2.0A
Battery charger	
Model No.	WUZ-AC01
Rated input	DC5V, 2.0A
Rated output	DC4.2V, 0.75A (When 5 batteries are charged)
Optional Parts (sold separately)	
Feeding adapter	Available with compatible power supplies (Rated output:DC5V, 2.1A)

* Can be fitted to either of the right eye or the left eye

* Battery replacement is possible without reboot (hot swap)

* Product specifications may change without notice.



Trademarks

- InfoLinker is a registered trademark of WESTUNITIS CO., LTD.
- QR codes are registered trademarks of Denso Wave Incorporated.
- The *Bluetooth*[®] word mark and logos are registered trademarks owned by Bluetooth SIG, Inc. and any use of such marks by WESTUNITIS CO., LTD. is under license.
- Microsoft[®], Windows[®], Windows Vista[®] are either registered trademarks or trademarks of Microsoft Corporation in the United States and/or other countries.
- Google and Android are trademarks of Google Inc.
- Mac, OS X are trademarks of Apple Inc., registered in the U.S. and other countries.
- All rights not specified in this manual belong to their owners.

Warranty information

Please consult either of the following importers.

Importer

- RYOSHO TECHNO SINGAPORE PRIVATE LIMITED
491B River Valley Road #11-01 Valley Point Singapore 248373
TEL: +65-6473-7118
FAX: +65-6479-8286
- RYOSHO (THAILAND) COMPANY, LIMITED
Unit 1507 Empire Tower 15th Floor, 1 South Sathorn Road Yannawa, Sathorn, Bangkok
10120 Thailand
TEL: +66-2-670-0385
FAX: +66-2-670-0389
- RYOSHO U.S.A., Inc. SAN JOSE HEADQUARTERS
2580 N.First Street, Suite 230, San Jose, CA 95131 U.S.A.
TEL: +1-408-474-7777
FAX: +1-408-474-7722
- RYOSHO U.S.A., Inc. ATLANTA BRANCH
3555 Koger Boulevard, Suite 320 Duluth, GA 30096, U.S.A.
TEL: +1-770-242-0606
FAX: +1-770-242-0372
- RYOSHO U.S.A., Inc. INDIANAPOLIS BRANCH
8425 Woodfield Crossing Boulevard, Suite 100, Indianapolis, IN 46240 U.S.A.
TEL:+1-317-469-4848
- Ryosho Europe GmbH
Mainzer Landstrasse 46, 60325 Frankfurt am Main, Germany
TEL: +49-69-7958390-0
FAX: +49-69-7958390-29

Manufacturer

WESTUNITIS CO., LTD

29F Grand Front Osaka Tower-A 4-20 Ofukacho,Kita-ku,Osaka,Japan

e-mail : contact@westunitis.co.jp

web : <http://www.westunitis.co.jp>